

SECTION A-A

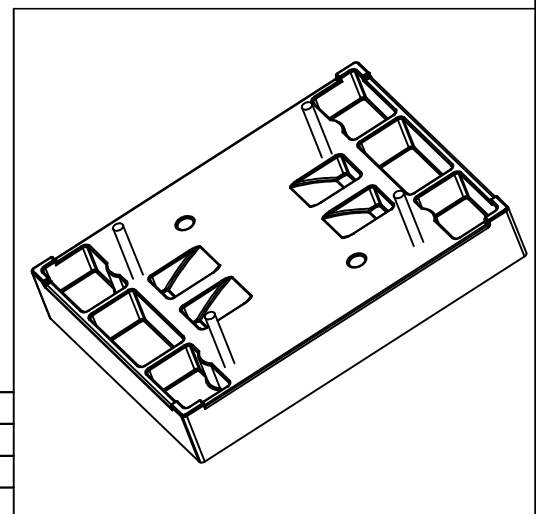
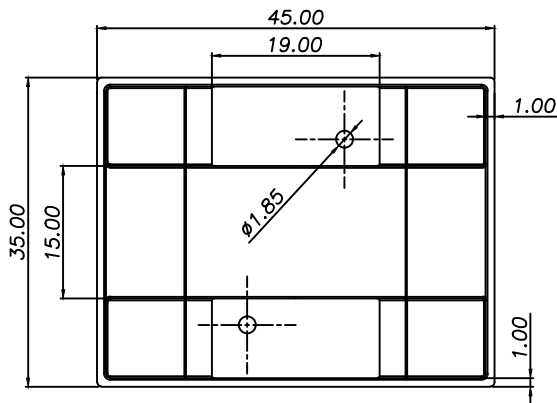

3.						
2.						
1.						
REVISION NOTE						

DRAWN	CHECKED	APPROVED	MATERIAL: PBT	UL REC.: UL94V-0	SCALE: 1/1	
			X=PIN LENGHT	DATE: 2019.01.28	TOLERANCE: +/-0.2	

	威海宁威塑胶制品有限公司			TITLE: 45*35*7.5 1.85孔		DWG NO
	TEL:0631-5781578		FAX:0631-5780578			