

SECTION A-A

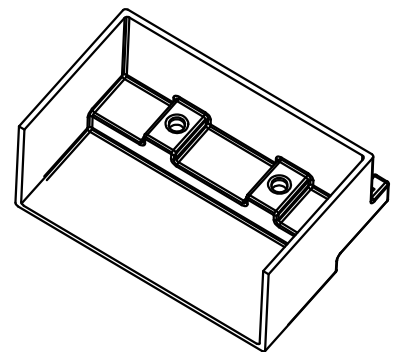
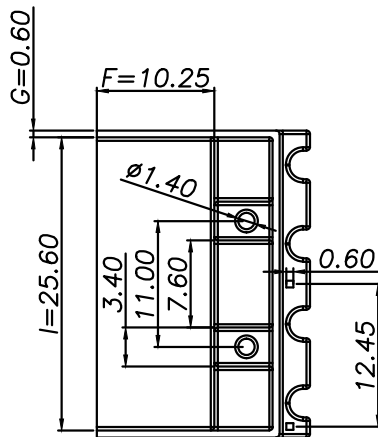
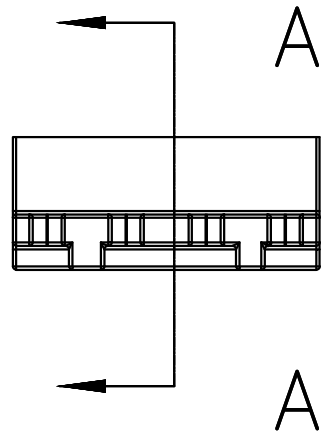
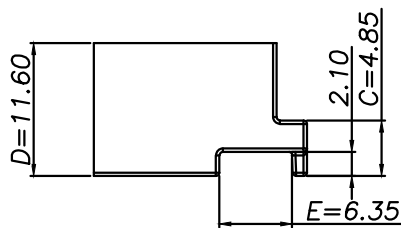
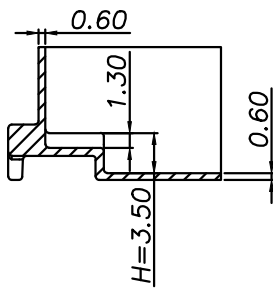

3.						
2.						
1.						
REVISION NOTE						

DRAWN	CHECKED	APPROVED	MATERIAL: LCP	UL REC.: UL94V-0	SCALE: 1/1	
			X=PIN LENGHT	DATE: 2019.07.11	TOLERANCE: +/-0.2	

	威海宁威塑胶制品有限公司			TITLE: EED25*16-CAP		DWG NO
	TEL:0631-5781578 FAX:0631-5780578					EED-071012-014